



# EZ Dock Product Guide

## Parts List

### DOCK SECTIONS

#### The Right Dock For Every Application.

Rugged, adaptable, reliable, safe—the EZ Dock system has it all. Our low-density polyethylene docks, boat lifts, and PWC lifts have a unique design that delivers outstanding load capacity, functionality, and safety. A variety of dock sections and lifts, plus an extensive selection of anchoring systems and accessories, make it easy to customize the system. For private, commercial, or public facilities, the EZ Dock system is a low-maintenance, versatile design that provides years of convenient, dependable use. EZ Dock's patented one-piece, self-floating design is fast and easy to install. Sections come in several sizes with evenly spaced coupler, hardware, and anchor pockets. You choose the configuration that suits your application.

#### Features & Benefits:

- Low maintenance
- Beige color
- Variety of anchoring options
- Convenient accessories
- Versatile modular design
- Secure connection couplers
- Strength and flexibility
- Safe, slip-resistant surface
- Four-season accessibility

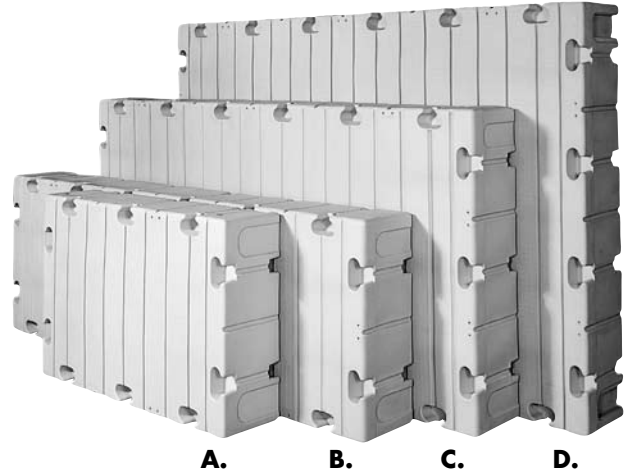

#### The New Half-Hexagon Dock Adds Versatility.

Imagine the configurations now made possible by this unique dock design. Combine modular half-hexagon sections for a platform of almost any size, or as a starting point for unusual dock angles.

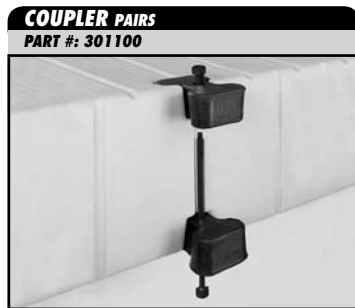

Special connection couplers are designed to allow sections to move independently under high-stress conditions, yet provide unified stability. Made with recycled material, the couplers are compounded to prevent fatigue problems. The composite coupler bolt and nut eliminate rusting in all water conditions. U.S. Patent #5,281,055

	SIZE	WEIGHT	FLOTATION CAPACITY	PART #
<b>A.</b>	40" x 5' x 15" 1m x 1.5m x 38cm	100 lbs. 45.4 kg	1000 lbs. 453.6 kg	204060
<b>B.</b>	40" x 10' x 15" 1m x 3.1m x 38cm	190 lbs. 86.2 kg	2000 lbs. 907.2 kg	204010
<b>C.</b>	60" x 10' x 15" 1.5m x 3.1m x 38cm	285 lbs. 129.3 kg	3000 lbs. 1360.8 kg	206010
<b>D.</b>	80" x 10' x 15" 2m x 3.1m x 38cm	385 lbs. 175 kg	4000 lbs. 1814.4 kg	208010
<b>E.</b>	60" x 10' x 15" 1.5m x 3.1m x 38cm	210 lbs. 95.3 kg	2000 lbs. 907.2 kg	260120

U.S. Patent #5,281,055

NOTE: Because of the rotomolding process, weights and dimensions may vary.

DESCRIPTION	PART #
Coupler set (bulk pack) w/hardware	301100
Coupler set (2 pair) w/hardware	301200
Coupler set (3 pair) w/hardware	301300



(800) 654-8168  
www.ez-dock.com

# EZ PORT BOAT LIFTS

## The Largest ONE-PIECE Boat & Personal Watercraft lift on the market!

Complete with all the features of the exceptional line of EZ Port products, the EZ Port 4 is designed specifically for 4-seat personal watercrafts and boats up to 20 feet in length. The EZ Port 4 also boasts a weight capacity of up to 2000 lbs., making it the most versatile docking solution on the market today.

### EZ Port 4 #208014PW

168" (4.25m) Long, 80" (2m) Wide, 15" (38cm) High.  
**Weight:** 500 lbs. (227 kg)  
**Flotation Capacity:** 1600 lbs. (725 kg)

### Part #208014PW

### EZ Port 4 (2') Extension #228014EX

24" (0.6m) Long, 80" (2m) Wide, 15" (38cm) High.  
**Weight:** 100 lbs. (45 kg)  
**Flotation Capacity:** 400 lbs. (181 kg)

### Part #228014EX

### EZ Port 4 (4') Extension #208014EX

48" (1.2m) Long, 80" (2m) Wide, 15" (38cm) High.  
**Weight:** 175 lbs. (80 kg)  
**Flotation Capacity:** 400 lbs. (181 kg)

### Part #208014EX

### EZ Port 4 Bow Section #208014BW

48" (1.2m) Long, 80" (2m) Wide, 15" (38cm) High.  
**Weight:** 175 lbs. (80 kg)  
**Flotation Capacity:** N/A

### Part #208014BW

The EZ Port 4 has a variety of configurations available, with standard features that virtually eliminate the competition in docking standards. These features include a flip-up front cleat and four other optional cleat positions, a fixed-position stern roller and three bedway rollers (each with 12 adjustment options), patented rotomolded polyethylene construction, slip-resistant surfaces and much more. These features, along with superior customer service, combine to make the EZ Port 4 the first of its kind—and the finest—in the industry.

The EZ Port 4 also attaches to any other EZ Dock section and has the option of utilizing EZ Dock access options, anchoring systems and accessories. To create the perfect installation, EZ Dock design engineers and installers are available to handle the technical details and ensure total customer satisfaction.

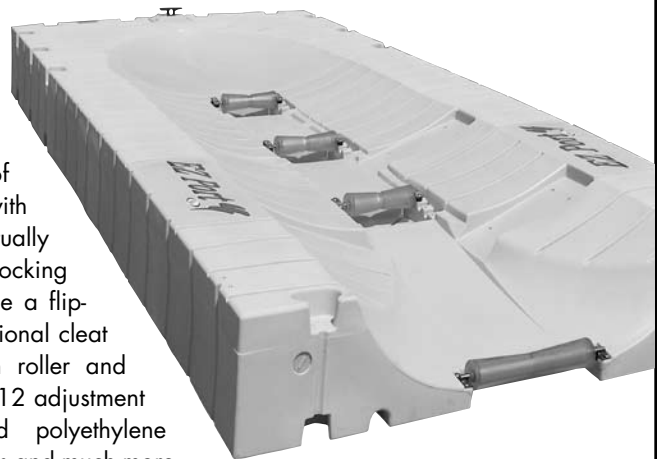

**For Boats up to 20'  
& 4-seat PWC's!**

# PERSONAL WATERCRAFT LIFTS

## Make Docking And Launching Part Of The Fun!

EZ Port is the simple drive-on, push-off method of dry docking. No winching, cranking, pumping, or hoisting. Self-floating EZ Port moves with changing water levels and helps protect the craft from damage caused by wind or wave action. EZ Port is so simple to use, even beginning PWC operators will find boarding and launching a breeze. And EZ Port is a one-piece unit which can be used alone or with other docks, so installation requires just a few tools and very little time. The EZ Port dry-docking system is the fastest, simplest, and easiest to use.

***EZ Port***

MODEL	SIZE	WEIGHT	FLOTATION CAPACITY*	PART #
<b>A.</b> EZ Port I	118" x 60" x 15" 3m x 1.5m x 38cm	230 lbs. 104 kg	625 lbs. 283.5 kg	206010PW
<b>B.</b> EZ Port II	127" x 60" x 15" 3.2m x 1.5m x 38cm	240 lbs. 109 kg	800 lbs. 363 kg	206011PW
<b>C.</b> EZ Port III	151" x 60" x 15" 3.8m x 1.5m x 38cm	280 lbs. 127 kg	1300 lbs. 590 kg	206013PW
<b>D.</b> Extension	20" x 60" x 15" .5m x 1.5m x 38cm	60 lbs. 27 kg	100 lbs. 45 kg	206010EX
Stainless Steel Extension	20" x 60" x 15" .5m x 1.5m x 38cm	60 lbs. 27 kg	100 lbs. 45 kg	206010EXSS

Supplemental flotation available for specific applications.

U.S. Patent # 398,576

\*When attached to an EZ Dock product.

NOTE: Because of the rotomolding process, weights and dimensions may vary.

### IDLE UP

### EASE INTO THROTTLE

### ROLL ABOARD

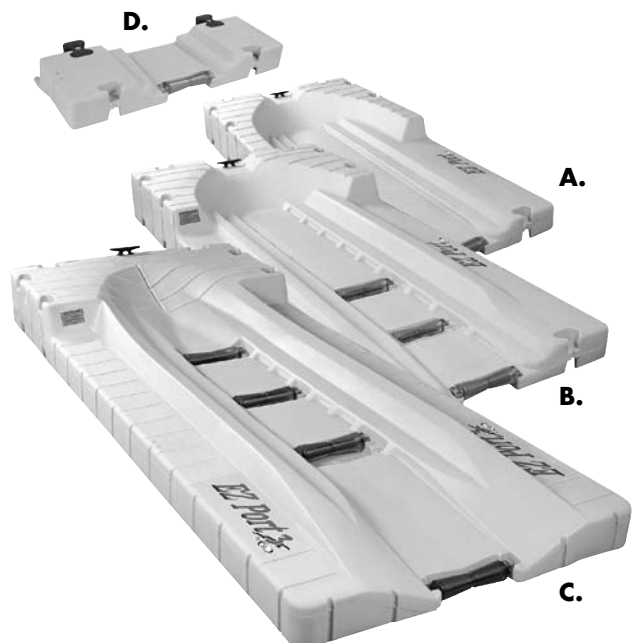

# PNEUMATIC AND WINCH-ON BOAT LIFTS



## Models & Pricing (Pneumatic Lifts):

<b>Standard Lift*</b> (4500 lb / 2041 kg) <b>Part #EZFL-45</b>	<b>#EZFL-45</b>	<b>Tritoon Lift*</b> (6600 lb / 2993 kg) <b>Part #EZFL-45T</b>	<b>#EZFL-45T</b>	<b>Pontoon Lift*</b> (6600 lb / 2993 kg - pontoons over 22' / 6.7 m) <b>Part #EZFL-66P</b>	<b>#EZFL-66P</b>
<b>Inboard Cross Member*</b> (4500 lb / 2041 kg - for ski boats) <b>Part #EZFL-45I</b>	<b>#EZFL-45I</b>	<b>Standard Lift*</b> (6600 lb / 2993 kg) <b>Part #EZFL-66</b>	<b>#EZFL-66</b>	<b>Tritoon Lift*</b> (6600 lb / 2993 kg - tritoons over 22' / 6.7 m) <b>Part #EZFL-66T</b>	<b>#EZFL-66T</b>
<b>Pontoon Lift*</b> (4500 lb / 2041 kg - pontoons up to 22' / 6.7 m) <b>Part #EZFL-45P</b>	<b>#EZFL-45P</b>	<b>Inboard Cross Member Lift*</b> (6600 lb / 2993 kg - for ski boats) <b>Part #EZFL-66I</b>	<b>#EZFL-66I</b>	<b>Standard Lift*</b> (8600 lb / 3900 kg) <b>Part #EZFL-86</b>	<b>#EZFL-86</b>

\* All pricing above is based on standard boat slips up to 11' / 3.35 m wide.

There is an additional charge for longer cross-arms to fit wider boat slips.

All pricing is FOB Monett. MSRP does not include freight or installation.

**Contact your local dealer to configure the perfect boat lift for your needs.**

## A Great Dock And Boat Lift, Too!

The EZ Port boat lift system can be used under conditions in which traditional lifts cannot. Because it floats, EZ Port can be used where water levels vary widely, where lake, river, and ocean bottoms are soft, or where access makes it difficult to install other types of lifts.

The EZ Port boat lift system is engineered for most fiberglass V-style hull boats. The multiple premium Stoltz adjustable rollers can accommodate boats with a 14° to 21° dead-rise angle. And eight different heights can be achieved by positioning the rollers in four possible configurations on two trays.

Docking is as simple as loading onto a roller bed trailer, and this unique docking option will keep your boat high and dry—free from impacts, floating debris, algae, and barnacles.

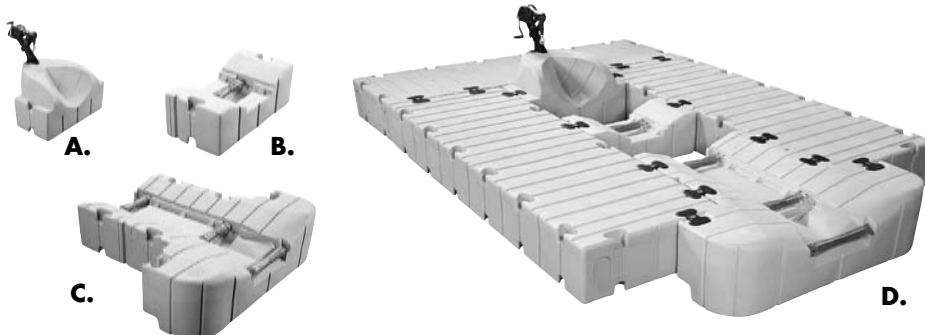

### A. Winch/Bow Stop Section #204005FL

20" (50cm) Long, 40" (1m) Wide, 15" (38cm) High.

**Section Weight:** 45 lbs. (20 kg)

**Winch:** Fulton XLT series 1400 lbs. (635 kg) winch, 20' (6.1m) strap, and hook.

**Part #204005FL**

### B. Intermediate Roller Section #204020FL

20" (50cm) Long, 40" (1m) Wide, 15" (38cm) High.

**Section Weight:** 45 lbs. (20 kg)

**Rollers:** One adjustable roller.

**Part #204020FL**

### C. Stern Roller Section #204670FL

60" (1.5m) Long, 40" (1m) / 70" (1.8m) Wide, 15" (38cm) High.

**Section Weight:** 150 lbs. (68 kg)

**Rollers:** Two adjustable rollers.

One fixed rear roller.

**Part #204670FL**

### D. Example: Assembled Lift

3 - 40" (1m) x 10' (3m) x 15" (38cm) dock sections combined with the Bow Stop, Intermediate Roller, and Stern Roller Sections.

**Maximum Boat Weight:** 1500 lbs. (680 kg)

**Overall Dock Dimensions:** 13' (4m) x 10' (3m)

**Boat Length:** 12' (3.7m) - 14' (4.3m)

*Additional flotation available for heavier boats.*

*Stern section adds 18" (46cm) to length of dock.*

*Because of the rotomolding process, weights and dimensions may vary.*



# ANCHORING

## ANCHORING PIPE WITH CAPS PART #: 100026 OR 100036

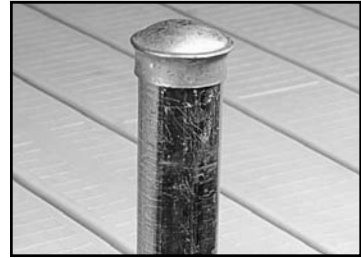

Galvanized steel, mechanical-grade pipe provides economical anchoring in shallow water. Pipe and caps sold separately.

### Pipe:

LENGTH	PART #
--------	--------

#### ▼ 2 3/8" O.D., 10 gauge:

16' (41cm)	1160250
18' (46cm)	118025
21' (53cm)	121025
24' (61cm)	124025

#### ▼ 3 1/2" O.D., 10 gauge:

16' (41cm)	1160350
18' (46cm)	118035
21' (53cm)	121035
24' (61cm)	124035

### Pipe Caps:

SIZE	PART #
------	--------

Fits 2 3/8" (6cm) O.D. pipe	100026
Fits 3 1/2" (9cm) O.D. pipe	100036

## PIPE AUGERS

### PART #: 100255 OR 100355



Auger with bolt and nut allows for drilling and setting pipe in lake, river, or ocean bottoms. Pipe sold separately.

DESCRIPTION	PART #
-------------	--------

For 2 3/8" (6cm) O.D. pipe	100255
For 3 1/2" (9cm) O.D. pipe	100355

## STIFF-ARM POST SLEEVE

### PART #: 800095-20



Sleeve for shoreline post attachment.

I.D.	PART #
------	--------

2 1/2" (6cm)	800095-20
3" (8cm)	800095-25
3 1/2" (9cm)	800095-30
4" (10cm)	800095-35

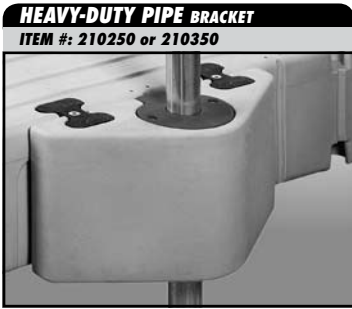

**HEAVY-DUTY PIPE BRACKET**  
ITEM #: 210250 or 210350

Heavy-duty polyethylene pipe bracket allows docks to adjust to changing water levels.

DESCRIPTION	PART #
For 2 1/2" (6cm) O.D. pipe	210250
For 3 1/2" (9cm) O.D. pipe	210350

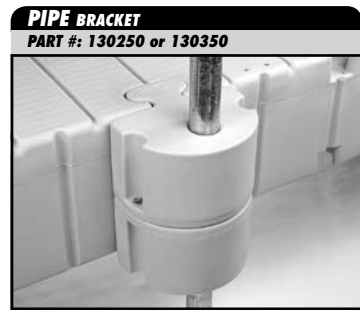

**PIPE BRACKET**  
PART #: 130250 or 130350

Standard-duty polyethylene bracket provides ample anchoring for EZ Port PWC lifts, or for smaller docks in moderate conditions.

DESCRIPTION	PART #
For 2 1/5" (6cm) O.D. pipe	130250
For 3 1/2" (9cm) O.D. pipe	130350



**ADAPTOR HINGE**  
PART #: 100750 or 100750SS

Reversible hinge allows you to bolt EZ Port PWC lifts or EZ Dock sections to other types of floating docks. Sold in pairs.

DESCRIPTION	PART #
Adaptor hinge	100750
All stainless steel	100750SS

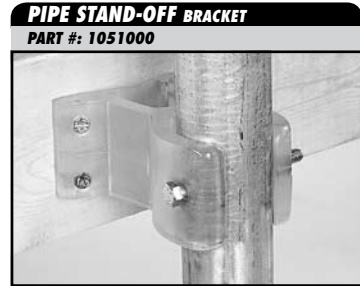

**PIPE STAND-OFF BRACKET**  
PART #: 1051000

Polyurethane bracket attaches top of pipe to stationary docks. Fits pipe 2.5" (6cm) to 3.5" (9cm) O.D.

DESCRIPTION	PART #
Pipe stand-off bracket	1051000

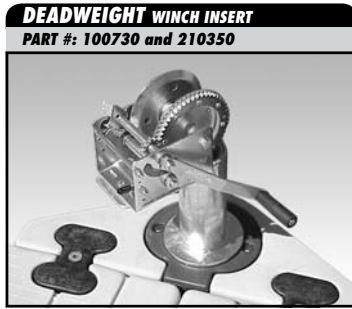

**DEADWEIGHT WINCH INSERT**  
PART #: 100730 and 210350

Deadweight insert and cable winch added to our polyethylene pipe bracket allow easy dock adjustment for water fluctuations. Cable sold separately.

DESCRIPTION	PART #
Deadweight winch insert	100730
For 3 1/2" (9cm) O.D. pipe	210350



**DEADWEIGHT BRACKET (SMALL)**  
PART #: 100740 or 100740SS

For light-duty anchoring with chain and/or to attach 4" (10cm) x 4" (10cm) railing or mooring posts. Chain sold separately.

DESCRIPTION	PART #
Deadweight bracket kit	100740
Stainless steel kit	100740SS



**DEADWEIGHT BRACKET (LARGE)**  
PART #: 210350 or 100725P

Add a deadweight insert to our heavy-duty polyethylene pipe bracket to anchor docks in deep water or over rocky bottoms.

DESCRIPTION	PART #
Bracket & insert for 3 1/2" O.D. pipe	210350
Deadweight insert for #210350 assy.	100725P

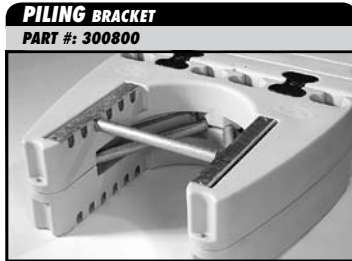

**PILING BRACKET**  
PART #: 300800

Heavy-duty polyethylene bracket with stainless steel hardware allows lateral position adjustment to attach to piles from 6" (15cm) to 18" (46cm) in diameter.

DESCRIPTION	PART #
Piling bracket	300800

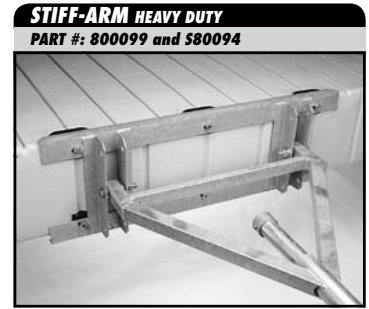

**STIFF-ARM HEAVY DUTY**  
PART #: 800099 and 800094

Anchor to a shoreline abutment or to a shoreline post with our heavy-duty stiff-arm. Light-duty stiff-arm bracket also available.

DESCRIPTION	PART #
Frame & Yoke (as shown)	800099
Sea wall attachment bracket	S80094

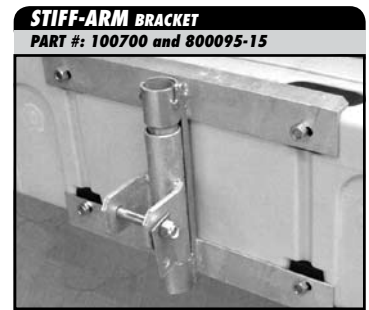

**STIFF-ARM BRACKET**  
PART #: 100700 and 800095-15

Includes hardware. Order stiff-arm insert, post sleeve, and anchoring pipe separately.

DESCRIPTION	PART #
Mainframe bracket	100700
2" I.D. post sleeve for stiff arm	80009515

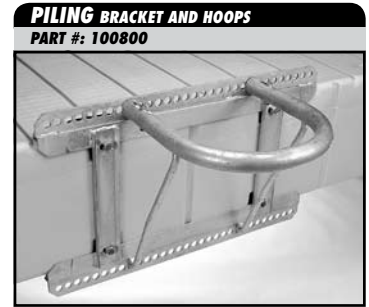

**PILING BRACKET AND HOOPS**  
PART #: 100800

Mainframe piling bracket is predrilled for hoops from 4" (10cm) to 24" (61cm) wide. Includes connectors with nuts. Hoops sold separately. *Stainless steel hardware available.*

DESCRIPTION	PART #
Mainframe piling bracket	100800

SIZE	PART #
4" (10cm)	100804
6" (15cm)	100806
8" (20cm)	100808
12" (30cm)	100812
16" (41cm)	100816
20" (51cm)	100820
24" (61cm)	100824

# ACCESSORIES and RAILING

## BARRIER-FREE RAILING

Galvanized steel 42" (1.1m) high guardrails conform with SOBA and ADA guidelines, and are designed to provide security with minimal obstruction. Choose the standard hot-dipped galvanized finish, or optional powder-coated finish—available in sand, royal blue, brown, forest green, and now available in stainless steel. Hardware included.

STYLE	WIDTH	GALV PART #	PWDR CTD #
910	10' (3m)	100910	105910
911	5' (1.5m)	100911	105911
912	10' (3m)	100912	105912
913R	10' (3m)	100913R	105913R
913L	10' (3m)	100913L	105913L
914R	5' (1.5m)	100914R	105914R
914L	5' (1.5m)	100914L	105914L
915	5' (1.5m)	100915	105915
916*	5' (1.5m)	100916*	105916*
917	80" (2m)	100917	105917
918	80" (2m)	100918	105918
919	40" (1m)	100919	105919
920*	40" (1m)	100920*	105920*

\*These styles are equipped with holders for fishing rods.

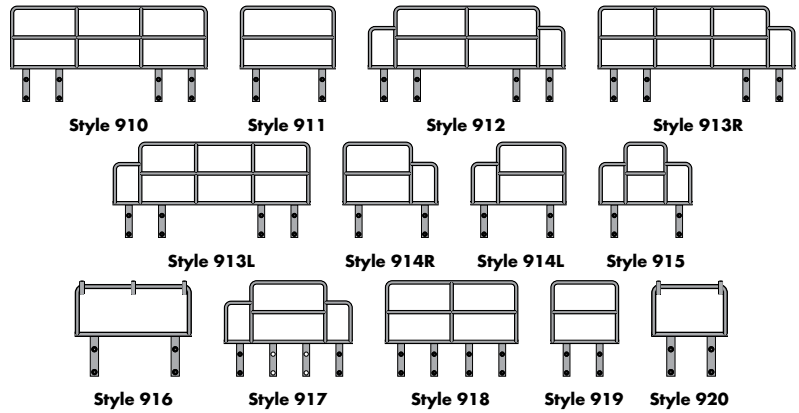

Now Available in Stainless Steel!

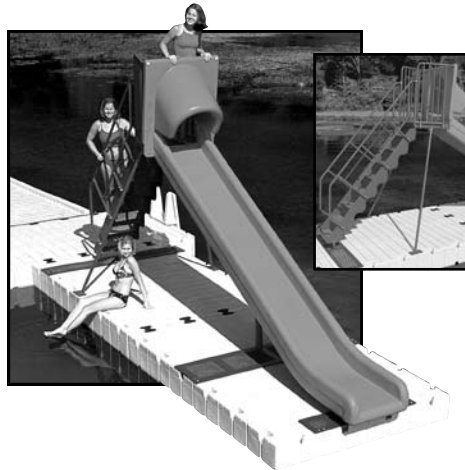

## Bring The Water Park To The Water Front with a Dock Slide!

Our popular dock slide utilizes rugged, durable, polyvinyl-coated steps, and a one-piece polyethylene bedway for a smooth ride. Install with almost any EZ Dock\* where water depth is more than 5 feet.

\*Requires two dock sections.

COLOR	PART #
Blueberry	300600
Forest Green	300600FG

## CORNER DOCK WHEEL

PART #: 300537



DESCRIPTION

PART #

Corner dock wheel

300537

## WINCH WITH STRAP FULTON

PART #: 91400



DESCRIPTION

PART #

Winch with strap fulcrum

91400

## SWIM LADDER

PART #: 300260



DESCRIPTION

PART #

Swim ladder

300260

## STORAGE BOX

PART #: 300750



DESCRIPTION

PART #

Storage box

300750

## CORNER STORAGE BOX

PART #: 300755



DESCRIPTION

PART #

Corner storage box

300755

Permanently mounted and constructed of weather-resistant materials, the storage box is a great place to store life jackets, towels, and any other essential supplies.

Roomy storage in a design that makes the most of space without interfering with foot traffic. Connection boxes for complete utility hookups through this box are available.

**POLYETHYLENE TRANSITION UNIT**  
PART #: 100717 or 100718 (shown)

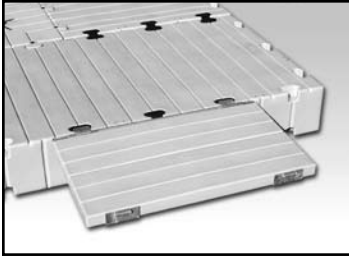

Hinged polyethylene plate creates a smooth transition between EZ Dock or EZ Port and another floating dock.

DESCRIPTION	PART #
Single-plank transition kit	100717
Double-plank transition kit	100718

**DOCK BUMPER**  
PART #: 300180

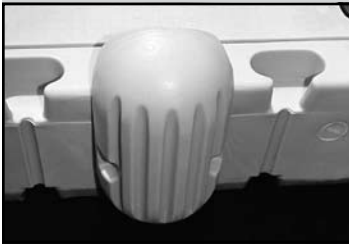

Made from specially formulated marine grade vinyl, the dock bumper is designed to protect the boat gunwales and rub-rails. Dock bumper will attach to dock using embedded T-nuts.

DESCRIPTION	PART #
Dock bumper	300180

**TIE-DOWN CLEATS**  
PART #: 300100



Tie-down cleats (8" [20cm]) and other accessories attach to heavy-duty stainless-steel T-nuts molded in pairs around dock section perimeters.

DESCRIPTION	PART #
Tie-down cleats	300100

**COUPLER INSTALLATION TOOL**  
PART #: 9000010



Coupler installation tool simplifies in-water connection of dock sections.

DESCRIPTION	PART #
Coupler installation tool	9000010
Coupler	311010
Coupler set	301100

**SECURITY CURBING**  
PART #: 35116



Constructed of polyethylene, curbing provides a safe border around dock edges for wheelchairs. (Available in brown only)

DESCRIPTION	PART #
Brown curb 10' section	35116
3" (8cm) Flathead screws	80530SS

**CORNER GUSSET**  
PART #: 300501



Polyethylene corner gusset adds deck surface and additional stability to dock fingers when needed. 33.5" (85cm) wide, 6" (15cm) high.

DESCRIPTION	PART #
Corner gusset	300501

**DOCK EDGING**  
PART #: 400117

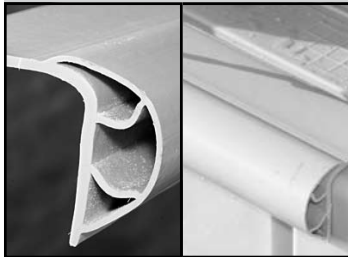

Constructed of durable vinyl, the edging provides a soft cushion to protect boats from the sides of docks and vice versa.

DESCRIPTION	PART #
10' Section	400117
Kit with 60'	406117

**SUPPLEMENTAL FLOTATION**  
PART #: 206013FL



Attaches under dock sections and EZ Port lifts to increase the flotation capacity in specific applications.

DESCRIPTION	PART #
Supplemental flotation	206013FL

**POLYETHYLENE BENCH HARDWARE KIT**  
PART #: 300965, 300970, AND 300966



A complete hardware kit that allows construction of a durable polyethylene dock bench. Arm brackets sold separately.

DESCRIPTION	PART #
Polyethylene dock bench	300965
P.E. Bench w/ arm brackets	300970
P.E. Arm kit300966	

**DOCK WHEELS**  
PART #: 900050



Steel frames with polyethylene wheels make movement of docks easier. Sold in pairs.

DESCRIPTION	PART #
Dock wheels	900050

**20" UTILITY CHANNEL**

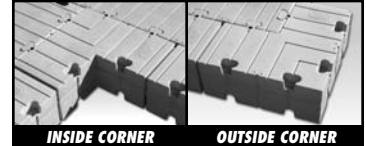
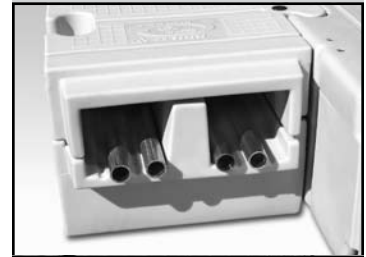

Two-piece, 20" wide chaseway attaches to side of dock sections to house conduit for utility lines. Available in 60" or 20" long sections, and with stainless steel hardware option. Inside and outside corners allow complete versatility when configuring docks for convenient utility connections.

DESCRIPTION	PART #
Utility Channel, 5' x 20"	302060
w/Stainless steel hardware	302060SS
Utility Channel, 20" x 20"	302020
w/Stainless steel hardware	302020SS
20" Inside Corner	302030
w/Stainless steel hardware	302030SS
20" Outside Corner	302040
w/Stainless steel hardware	302040SS

# DOCK ACCESS

## Bring The Whole Gang.

Our new polyethylene gangway offers the same durability, stability, and modular versatility of our docks. It will last longer than wood, and its slip-resistant surface enhances safety. Available in 6' sections which can be combined to lengths of 12' and 18'. Railings are also available.

Description	Part #
Shore end 4' wide aluminum transition plate w/ hinges	400401
6' Long polyethylene gangway section	400406
12" Tube support kit for polyethylene gangway kit	401412
18" Tube support kit for polyethylene gangway kit	401418
P.E. gangway-to-hinge kit only, w/stainless steel hdwe.	400420SS
Polyethylene gangway-to-hinge kit only	400430
Polyethylene gangway to abutment kit	400450
P.E. gangway to abutment kit, w/stainless steel hdwe.	400450SS
Polyethylene gangway to 60" float kit	400460
P.E. gangway to 60" float kit, w/stainless steel hdwe.	400460SS
Polyethylene gangway to 80" float kit	400480
P.E. gangway to 80" float kit, w/stainless steel hdwe.	400480SS



## Polyethylene Gangway

(Gangway shown with optional railing)

### GANGPLANK MOUNTING KIT PART #: 100240 or 100340 or 100600



Galvanized steel hinge bracket and hardware, for wood walkways 24" (61cm), 34" (86cm), or 60" (1.5m) wide.

Kits include hardware connectors with nuts, hinge-to-float bracket, hinge-to-plank bracket and 2 gangplank stiffeners with carriage bolts, nuts, and washers. Lumber not included.

WIDTH	FITS FLOAT WIDTH	PART#
24" (61cm)	40" x 60" x 80" Float, 2 pocket connection	100240
34" (91cm)	40" x 60" x 80" Float, 2 pocket connection	100340
60" (1.5m)	60" Float, 3 pocket connection	100600
60" (1.5m)	80" Float, 4 pocket connection	100680
▼ Shore-end hinge adaptor kits		
	Kit for 34" (.9m) gangway	150340
	Kit for 60" (1.5m) gangway	150600
	Kit for 34" (.9m) gangway abutment w/ roller	140340
	Kit for 60" (1.5m) gangway abutment w/ roller	140600

### GANGWAY ALUMINUM PART #: 300310 to 500530

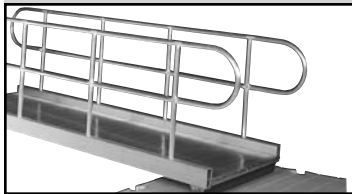

Gangway has welded construction with slip-resistant walkway, side curb, and rails. Lengths from 10'-30' (3m-9.1m), and widths from 3'-5' (1m-1.5m).

WIDTH	LENGTH	PART #
3'	10'	with railing 300310
3'	14'	with railing 300314
3'	20'	with railing 300320
3'	25'	with railing 300325
3'	30'	with railing 300330
5'	10'	with railing 500510
5'	14'	with railing 500514
5'	20'	with railing 500520
5'	25'	with railing 500525
5'	30'	with railing 500530

### PLANK GANGWAY PART #: 200200

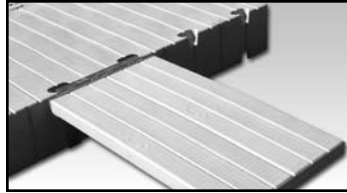

Hinged polyethylene panel creates a smooth transition between shore grade and deck surface.

DESCRIPTION	PART #
Plank Gangway	200200

### ABUTMENT HINGE BRACKET PART #: 50501SS or 50502SS

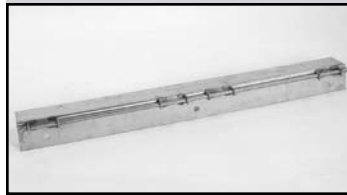

Bracket attaches to the shore end of 3' (91cm) and 5' (1.5m) aluminum gangways bolting to shoreline abutment.

WIDTH	PART #
48"	50501SS
60"	50502SS

### FLOAT HINGE BRACKET PART #: 100650SS or 100850SS



Hinged bracket with hardware attaches gangway to dock. Available in 60" (1.5m) and 80" (2m) widths.

POCKETS	PART #
3	100650SS
4	100850SS

### TRANSITION PLATE PART #: 300301 or 400401 or 500501

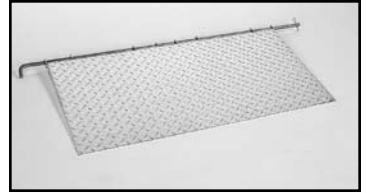

Hinged aluminum plate creates smooth transition between shore grade and aluminum gangway deck.

WIDTH	PART #
3' (91cm) w/hinges	300301
4' (1.2m) w/hinges	400401
5' (1.5m) w/hinges	500501

### GANGWAY ROLLER KIT PART #: 300300 or 300400



Gangway roller kit allows end of gangway to adjust with changing water levels. Available for all gangway kits.

DESCRIPTION	PART #
Roller Kit w/ PVC roller	300300
▼ Schedule 80 PVC pipe	105030
36" (.9m) long, 3.5" dia.	
Roller Kit w/ galvanized roller	300400
▼ Galvanized steel pipe	105035
56" (1.4m) long, 3.5" dia	



(800) 654-8168  
www.ez-dock.com

© 2007 EZ Dock, Inc.  
EZ Dock is a division of Playpower, Inc.  
ez-pg-US-1-07.  
Prices subject to change without notice.  
Prices do not include shipping or installation.